



Instruction Manual

Bresser Goto-Kit for equatorial EQ-5 Mounts



Art.-Nr. 49-51750

Telescope assemblies

The Mount

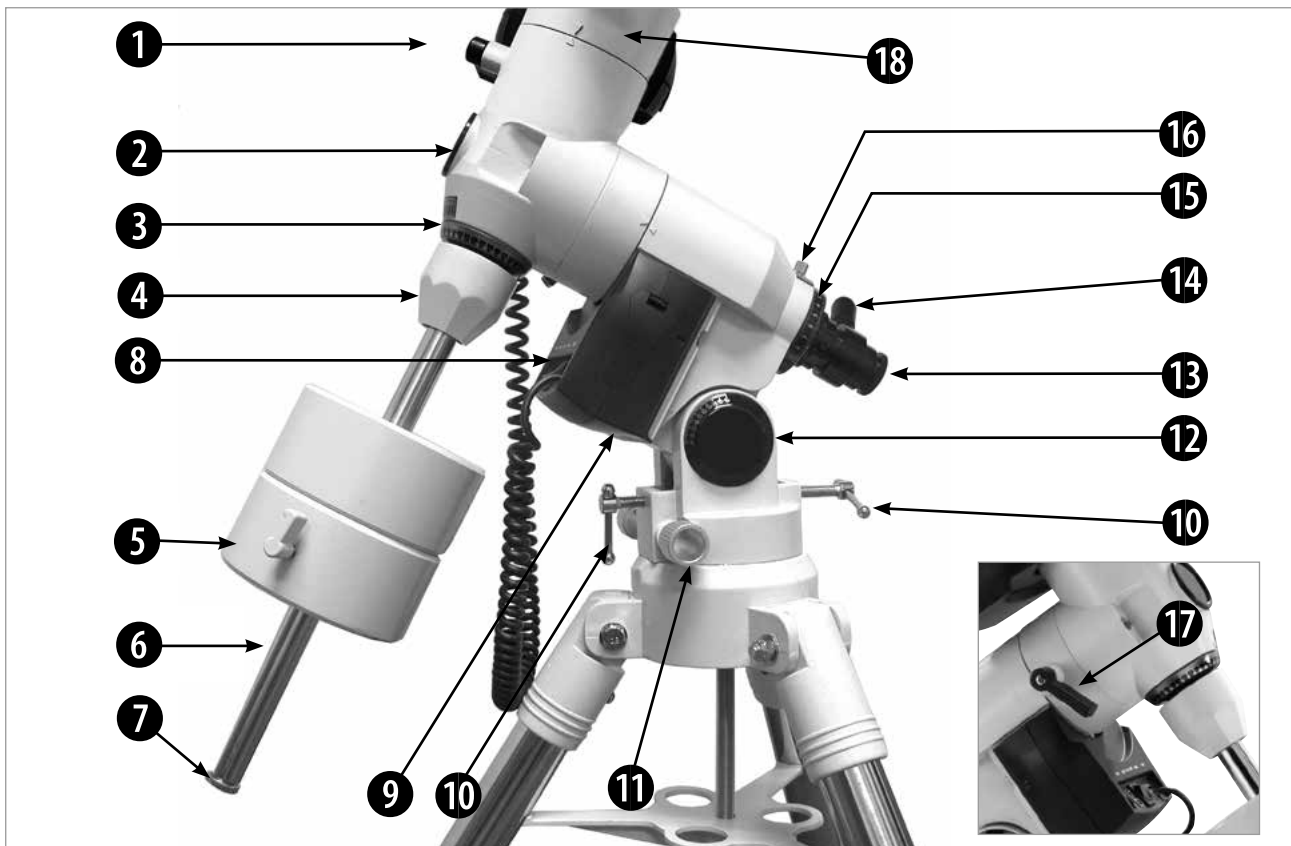

Fig. 1a: The Mount; detail shows opposite side of mount.

Legend

- | | | |
|------------------------------|---------------------------------|-----------------------------------|
| 1. Dec. Lock | 7. Counterweight Safety Cap | 14. Polar Alignment Reticle, LED |
| 2. Polar VF Cap | 8. Computer Control Panel | 15. R.A. Setting Circle |
| 3. Dec. Setting Circle | 9. R.A. Motor Drive | 16. R.A. Setting Circle Lock Knob |
| 4. Counterweight Shaft Base | 10. Latitude Adjustment Handles | 17. R.A. Lock |
| 5. Counterweight, Lock Knobs | 11. Azimuth Control Knobs | 18. Dec. Motor Drive |
| 6. Counterweight Shaft | 12. Latitude Dial | |
| | 13. Polar Alignment VF | |

The Handbox



Legend

- | |
|-----------------------------------|
| 1. LCD-Display |
| 2. ENTER Key |
| 3. MODE Key |
| 4. + Key |
| 5. Arrow Keys |
| 6. Number Keys |
| 7. Stop Key |
| 8. Help Key |
| 9. Coil Cord Port |
| 10. Coil Cord |
| 11. Key for the Utility Light |
| 12. Utility Light |
| 13. Port for further developments |

Fig. 2:
The Handbox

Parts overview

- 1 **Declination (Dec.):** Controls the manual movement of the telescope. Turning the Dec. lock counterclockwise unlocks the telescope enabling it to be freely rotated by hand about the Dec. axis. Turning the Dec. lock clockwise (to a firm feel only) tightens the lock and prevents the telescope from being moved manually, but engages the Dec. motor drive for Handbox operations.
- 2 **Polar Viewfinder Cap:** Remove this cap when using the polar viewfinder.
- 3 **Dec. Setting Circle**
- 4 **Counterweight Shaft Base:** Thread, along with the shaft, to the mount.
- 5 **Counterweight and Counterweight Lock Knob:** Counterbalances the weight of the optical tube, and adds stability to the mount. Tighten the lock knob on the side of the counterweight to a firm feel to prevent the weight from sliding on the shaft.
- 6 **Counterweight Shaft:** Slide the counterweight onto this shaft.
- 7 **Counterweight Safety Cap:** Prevents the counterweight from accidentally slipping off the end of the counterweight shaft.
- 8 **Computer Control Panel (see Fig. 1b):**
 - **Handbox (HBX) Port:** Plug the handbox coil cord (9, Fig. 2) into this port.
 - **12v DC Power Connector:** optional power connector (Art. No. 49-30000 or 04-55121).
 - **LED:** Illuminates when power is supplied to the handbox and the telescope's motor drive.
 - **ON/OFF Switch:** Turns the Computer Control Panel and handbox ON or OFF.
 - **ST-4 Autoguider Port:** Suitable for any ST-4 compatible autoguider system.
 - **Dec Port:** Plug the coil cord from the Dec. motor assembly into this port for the handbox to control the motor drive.
- 9 **Right Ascension (R.A.) Motor Drive Assembly:** Controlled by the handbox. Moves the optical tube along the R.A. axis. The R.A. Lock (17, Fig. 1a) must be tightened to a firm feel in order for the R.A. motor to operate.
- 10 **Latitude Adjustment T-Handles (10, Fig. 1a):** Sets the latitude of your observing location. The two T-handle screws work in a „push - pull“ operation—as you tighten one, loosen the other.
- 11 **Fine Azimuth Control Knobs:** Fine tune the side-to-side movement of the telescope when centering Polaris in the telescope eyepiece or when using the polar alignment viewfinder.
- 12 **Latitude Dial:** Set the latitude of the observing site on this dial using the latitude T-handle screws.
- 13 **Polar Alignment Viewfinder:** Allows you to precisely polar align the telescope.
- 14 **Polar Alignment Viewfinder Reticle and LED Knob:** Rotate the knob to switch on or off the LED that illuminates the reticle within the polar alignment finder. Be sure to turn off the LED when finished with the polar viewfinder.
- 15 **R.A. Setting Circle**
- 16 **R.A. Setting Circle Lock Knob:** Rotate the knob to lock the R.A. Setting Circle in place.
- 17 **R.A. Lock:** Controls the manual movement of the telescope. Turning the R.A. lock counterclockwise unlocks the telescope enabling it to be freely rotated by hand about the R.A. axis. Turning the R.A. lock clockwise (to a firm feel only) tightens the lock and prevents the telescope from being moved manually, but engages the R.A. motor drive for Handbox operations.
- 18 **Dec. Motor Drive Assembly:** Controlled by the handbox. Moves the optical tube along the Dec. axis. The Dec. Lock (1, Fig. 1a) must be tightened to a firm feel in order for the Dec. motor to operate.

Telescope assemblies

The Motor Drive Systems

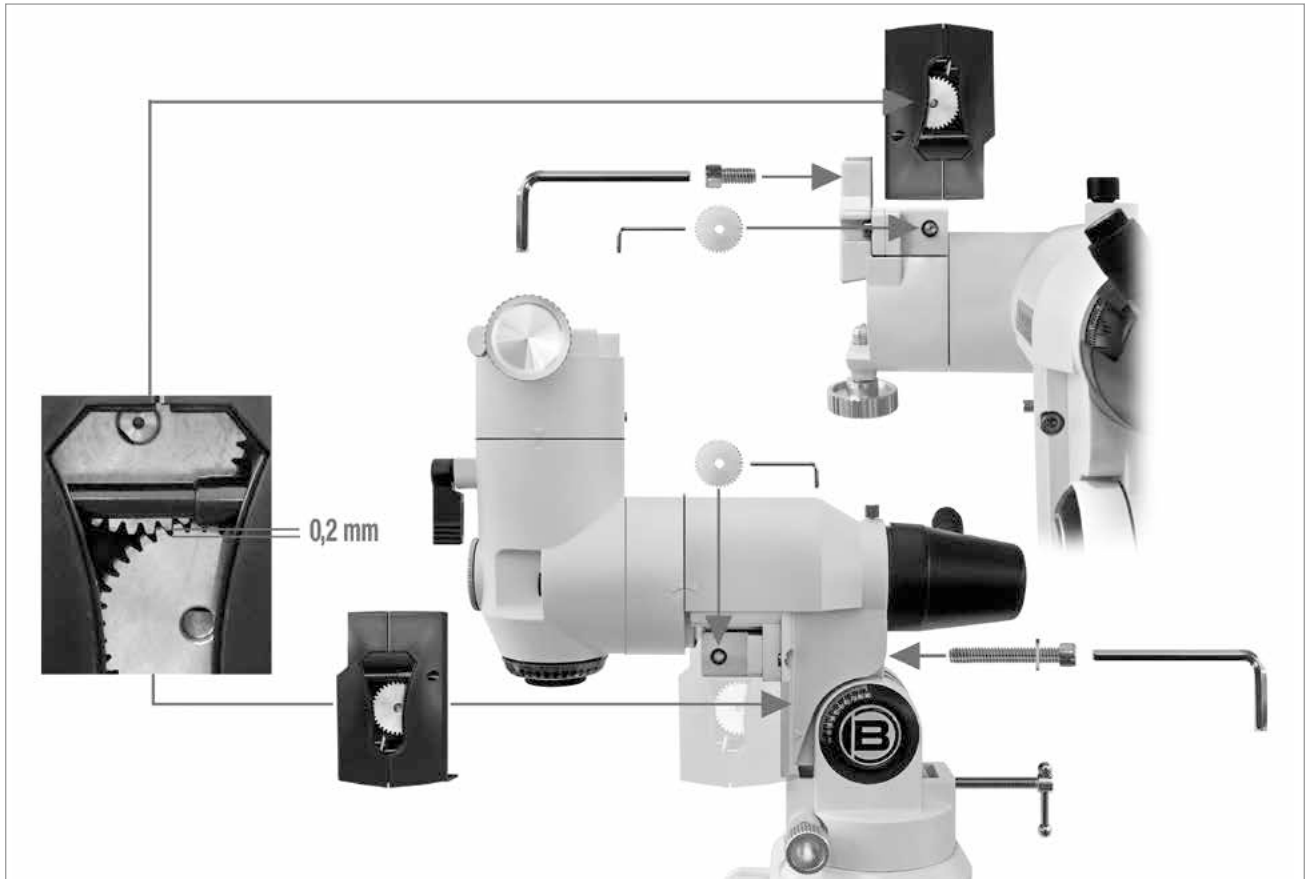

Fig. 1b: Control-Panel of RA motor



Fig. 1c: Control-Panel of DEC Motor

Installing the motors



Warranty

The period of warranty is 2 years, beginning on the day of purchase. Please keep the cash receipt as evidence of purchase. Devices which become defective during the warranty period can be returned to the dealer where the device was bought. The repaired device or a new one will then be returned to you. In the case of defects which occur after the end of the warranty period, the devices can also be returned.

However, repairs which become necessary after the end of the warranty period will be subject to a service fee.

Important:

Make sure to return the device carefully packed in the original packaging in order to prevent transport damage. Please also enclose the cash receipt (or a copy). This warranty does not imply any restriction of your statutory rights.

Your dealer:

Name:

Postcode / Place:

Street:

Telephone:

Date of purchase:

Signature:

Errors and technical changes reserved. Images may partially differ from the original.

Index



WARNING!

Never use a Telescope to look at the Sun! Looking at or near the Sun will cause instant and irreversible damage to your eye. Eye damage is often painless, so there is no warning to the observer that damage has occurred until it is too late. Do not point the telescope or its viewfinder at or near the Sun. Do not look through the telescope or its viewfinder as it is moving. Children should always have adult supervision while observing.

- Telescope assemblies 2
 - The Mount.....2
 - The Handbox2
- Parts overview Mount 3
- Telescope assemblies 4
 - The Motor Drive Systems4
- Installing the motors 5
- Warranty 5
- Telescope setup 7
 - Balancing the telescope 7
- Automatic Tracking8
 - Setting the Polar Home Position8
 - Observing by Moving the Telescope Manually9
 - Activate the Arrow Keys9
 - Slew Speeds9
 - Using GO TO capabilities10
 - Moving through the menus.....10
 - Tour the Cosmos with Just the Push of a Button10
- The Handbox11
 - Features of the Handbox11
 - Main menu of the Telescope control.....13
 - Initializing the handbox14
 - One Star Align.....14
 - Two- and Three-Star Align15
 - Synchronisation15
 - RA + DEC Backlash compensation15
 - Navigation to the Target Objects.....16
 - Customer Objects16
 - Celestial Coordinates.....17
- Utility Menu17
 - Current Objects.....17
 - Rise and Setting Time.....17
 - Lunar Phase17
 - Timer17
 - Alarm18
 - Eyepiece Field of View18
 - Eyepiece Magnification.....18
 - LCD Illumination.....18
 - Park Scope18
- Settings18
 - Date and Time18
 - Daylight Saving18
 - Observing Site19
 - Astronomical/Terrestrial20
 - Tracking Mode20
 - Telescope Mount20
 - Tracking Speed.....20
 - Language20
 - Reset20
- Polar Alignment21
 - The Polar Alignment Viewfinder.....21
 - Adjusting the polar viewfinder (EXOS 2).....21
 - Polar alignment by using the polar viewfinder22
- How to find Polaris.....24
- Distances in space25
- Possible observation targets.....26
- Technical data27

Telescope setup

Balancing the telescope

In order for the telescope to be stable on the tripod and also for it to move smoothly, it must be balanced. To balance the telescope, unlock the Right Ascension or R.A. lock (**17, Fig. 1a**). When this axis is unlocked, the telescope pivots on the R.A. axis. Later in the procedure, you will also unlock the Declination or Dec. lock (**1, Fig. 1a**). When unlocked, the telescope pivots on the Dec. axis. Most of the motion of the telescope takes place by moving about these two axes, separately or simultaneously. Try to become familiar with these locks and observe how the telescope moves on each axis. To obtain a fine balance of the telescope, follow the method below:

1. Firmly hold the optical tube secure so that it cannot accidentally swing freely. Loosen the R.A. lock (**17, Fig. 1a**). The optical tube now moves freely about the R.A. axis. Rotate the telescope so that the counterweight shaft (**6, Fig. 1a**) is parallel (horizontal) to the ground.

REMARK

The LXD-75 mount comes with a 4,5 kg counterweight. In case that you do not succeed in balancing the mount., it could be necessary to use a second or third counterweight . Those are available as an optional accessory. Make sure however that a higher total weight affects stability of your complete setup negatively.

2. Unlock the counterweight lock knob and slide the counterweight (**5, Fig. 1a**) along the counterweight shaft until the telescope remains in one position without tending to drift down in either direction. Then re-tighten the counterweight lock knob, locking the counterweight in position.
3. Again, hold the optical tube so that it cannot accidentally swing freely. Lock the R.A. lock (**17, Fig. 1a**), and unlock the Dec. lock (**1, Fig. 1a**). The telescope now is able to move freely about the Dec. axis. Loosen the cradle ring lock knobs so that the main tube slides easily back and forth in the cradle rings. Move the main tube in the cradle rings until the telescope remains in one position without tending to drift down in either direction. Re-lock the Dec. lock (**1, Fig. 1a**).

The telescope is now properly balanced on both axes. Next, the viewfinder must be aligned.

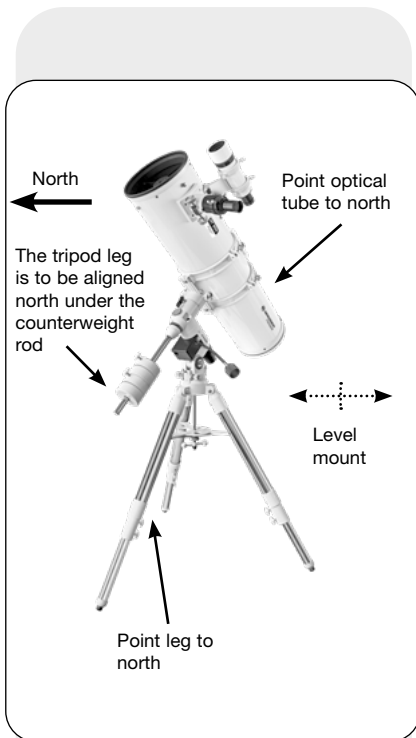

Fig. 3a: The polar home position, side view.



Fig. 3b: The polar home position, front view.

Automatic Tracking

As the Earth rotates under the night sky, the stars seem to move from east to west. The speed at which the stars carry out this movement, is called „Sideral Speed“. You can now set up your telescope so that it moves in conjunction with sidereal speed. By doing this, it tracks the objects and stars in the night sky automatically. This tracking function is provided by the actuator drive set, available as an accessory.

Setting the Polar Home Position

1. Level the mount, if necessary, by adjusting the length of the three tripod legs.
2. Unlock the R.A. Lock (17, Fig. 1a). Rotate the Optical Tube Assembly until the counterweight shaft is pointing straight down over the mount. See Figs. 3a and 3b.
3. If you have not already done so, lift the telescope assembly and turn it so that the tripod leg beneath the counterweight rod faces approximately North (South in the Southern Hemisphere). Release the Dec. lock (1, Fig. 1a) of the tripod, so that the optical tube (10, Fig. 3a) may be rotated. Rotate the optical tube until it points North (or South in the Southern Hemisphere). Then re-tighten the lock. Locate Polaris, the North Star, if necessary, to use as an accurate reference for due North (or Octantis in the Southern Hemisphere).
4. If you have not already done so, determine the latitude of your observing location. See LATITUDE CHART for a list of latitudes of major cities around the world. Use the latitude T-handle screws (10, Fig. 1a) to tilt the telescope mount so that the pointer indicates the correct latitude of your viewing location on the latitude dial (12, Fig. 1a).
5. If steps 1 through 4 above were performed with reasonable accuracy, your telescope is now sufficiently well-aligned to Polaris, the North Star, for you to begin making observations.

Once the mount has been placed in the polar home position as described above, the latitude angle need not be adjusted again, unless you move to a different geographical location (i.e., a different latitude).

IMPORTANT NOTE:

So that the Goto functionality is set in the most accurate way, the RA-Axis should be precisely aligned, as much as possible, to the celestial pole using the Scope Polefinder (13, fig 1a). See also the section „Improving the Pole Alignment“.

Observing by Moving the Telescope Manually

After the telescope is assembled and balanced as described previously, you are ready to begin manual observations. View easy-to-find terrestrial objects such as street signs or traffic lights to become accustomed to the functions and operations of the telescope. For the best results during observations, follow the suggestions below:

- When you wish to locate an object to observe, first loosen the telescope's R.A. lock (**17, Fig. 1a**) and Dec. lock (**1, Fig. 1a**). The telescope can now turn freely on its axes. Unlock each axis separately and practice moving your telescope. Then practice with two unlocked axes at the same time. **It is very important to practice this step** to understand how your telescope moves, as the movement of an equatorial mount is not intuitive.
- Use the aligned viewfinder to sight-in on the object you wish to observe. When the object is centered in the viewfinder's crosshairs, re-tighten the R.A. and Dec. locks.
- Once centered, an object can be focused by turning one of the knobs of the focusing mechanism.

Note:

Upon initial switching on, the hand box prompts you for country and location (Observing Site). You must manually search for your country at this point and then the nearest city; the entries will be saved automatically. A subsequent change is possible in the setup menu under „Location“.

Activate the Arrow Keys

The arrow keys of the handbox allow you to slew (move) the telescope up, down, right, or left. The following procedure describes how to activate the arrow keys:

1. After the power supply is applied in accordance with regulations and the hand box cable is inserted into the HBX port of the operating panel (Fig. 1b), a copyright message initially appears on the LED display (1, Fig. 2).
2. After switching on, you will be prompted for the date, time and the summertime arrangements, in addition to the observing site.
3. The main screen appears in the display upon completion of the entries.

You now can use handbox's Arrow keys to move the telescope to observe.

Slew Speeds

The hand box offers a total of eight slew speeds which are directly proportional to the sidereal speed. They have been designed so that special functions can be carried out optionally. Press the number button and adjust the speeds so that the slew speed is modified; this then appears to the bottom left of the LCD screen of the hand box.

The nine available speeds are:

Number Key 1 =		Guide (0.25 arc-min/sec or 0.004°/sec)
Number Key 2 =	2x =	2 x sidereal (0.5 arc-min/sec or 0.008°/sec)
Number Key 3 =	8x =	8 x sidereal (2 arc-min/sec or 0.033°/sec)
Number Key 4 =	16x =	16 x sidereal (4 arc-min/sec or 0.067°/sec)
Number Key 5 =	64x =	64 x sidereal (16 arc-min/sec or 0.27°/sec)
Number Key 6 =	128x =	30 arc-min/sec or 0.5°/sec
Number Key 7 =	256x =	60 arc-min/sec or 1.0°/sec
Number Key 8 =	512x =	120 arc-min/sec or 2°/sec
Number Key 9 =	Max. =	120 arc-min/sec or 2°/sec

Speeds 1, 2, or 3: Best used for fine centering of an object in the field of view of a higher power eyepiece, such as a 12mm or a 9mm eyepiece.

Speeds 4, 5, or 6: Enables centering an object in the field of a low-to-moderate power eyepiece, such as the standard Super Plössl 26mm.

Speeds 7, 8 or 9: Best suited for the coarse setting of an object. With this, the telescope moves quickly from one place to another in the sky.

Tip:

When multiple choices are available within a menu option, the current option is usually displayed.

Definition:

Initialization is a procedure that ensures that the hand box operates correctly. When you first use the hand box, it doesn't yet know where the observation location site is or the time or date of the observation session.

You will enter information, such as the current time and date, and observation location.

The hand box uses this information to precisely calculate the location of celestial objects (such as stars and planets) and to automatically move your telescope correctly for various operations.

Using GO TO capabilities

Before you can use GO TO capabilities, you must first:

- Learn how the keys move through the menus
- Initialize the computer control
- Place the telescope in the polar home position, if you have not already done so.
- Select **ALIGN: One-Star** from Menu „Align“

Moving through the menus

The menus are organized for quick and easy navigation.

- Press **ENTER** to go deeper into menu levels.
- Press **MODE** to move back toward the top menu level.
- Press the **SCROLL** keys **▲ ▼** to move up and down through the options available for each menu level.
- Press the arrow keys to enter characters.

You also move your telescope with the arrow keys if no input is required.

Tour the Cosmos with Just the Push of a Button

Control of the telescope mount is through the operation of the handbox. Nearly all functions of the telescope are accomplished with just a few pushes of the buttons. Some of the major features of the handbox are:

- Automatic GO TO capability: Automatically move the telescope to any of the more than 30,000 objects stored in the object library.
- Take a guided tour of the best celestial objects to view on any given night of the year.
- Access a glossary of astronomical terms.
- Calculate which magnification the eyepiece used gives in conjunction with a specific telescope.

The Handbox

The Handbox

Legend

1. LCD-Display
2. ENTER Key
3. MODE Key
4. + Key
5. Arrow Keys
6. Number Keys
7. Stop Key
8. Help Key
9. Coil Cord Port
10. Coil Cord
11. Key for the Utility Light
12. Utility Light
13. RS-232-Interface

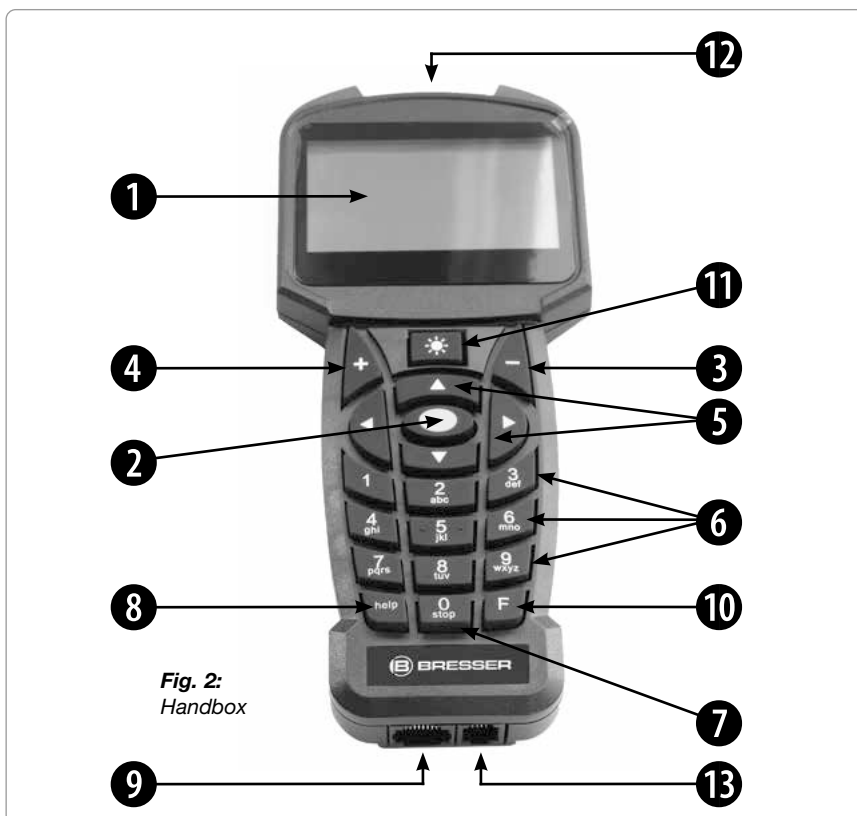

Fig. 2:
Handbox

Features of the Handbox

1. **The eight-line LCD display (1, Fig. 2)** – It functions as an interface between the hand box and the telescope.

There are a wide variety of values / information or individual menu options of the menu structure displayed in order to enable the operation.

2. **ENTER Key (2, Fig. 2)** – Press to go to the next menu level or to choose an option in a menu. The ENTER key is similar to the RETURN or ENTER key on a computer.

3. **MODE Key (3, Fig. 2)** – Press to return to the previous menu level. The top menu level is "Select Item." The MODE key is similar to the ESCAPE key on a computer.

4. **+ Key (4, Fig. 2)** – With this, the most recently tracked objects can be recalled for quick access. Use the direction buttons when selecting an observation object and press the ENTER button. The telescope control subsequently positions the selected object in the visual field. It may occur that the object does not appear in the centre of the visual field after the positioning. Centre, in this case, the object with the direction buttons.

5. **Arrow Keys (5, Fig. 2)** – Press to slew the telescope in a specific direction (up, down, left, and right), at any one of nine different speeds. See **SLEW SPEEDS**, page 9. The following functions are additionally possible using the arrow buttons:

- *Data entry* - Press the „up“ - and „down“ buttons to scroll through the letters of the alphabet or through the sequence of numeric digits. The „down“ button starts with the letter „A“, the „up“ button with the number „9“. With the „left“ - and „right“ buttons, you can move the blinking cursor in the LCD display to the left or to the right.
- *RA / Dec-alignment* - With the „right“ - and „left“ - buttons, you can swivel the telescope in the hour axis. The „up“ and „down“ buttons move the telescope in declination.

NOTE:

In case of a malfunction of the tracking, please press the stop button 2 x!

- Within a pre-selected menu, these buttons allow access to various options of the database. The options in the menu come - one after the other - in the second line, for display. If you press the „up“ and „down“ buttons, you move through the various options. Using the „up“ and „down“ buttons, you are also able to scroll through the letters of the alphabet, or through the numeric digits.

- 6. Number Keys (6, Fig. 2)** – Press to input digits 0 to 9. When data is not being entered, the Number keys can be used to change the slew speed. To operate, just press a number key (1 is the slowest speed, 9 is the highest speed). Press the Number key „0“ to turn on and off the red utility light on the top of the handbox.
- 7. Stop button (7, Fig. 2)** – This allows you to interrupt any driven movement of the telescope. After pressing again, the telescope once again initiates operation of the last executed function.
- 8. Help button (8, Fig. 2)** – This allows you to access the help function. As soon as your queries have been dealt with sufficiently by the help function, press the MODE button and return to the original display in this manner. Proceed with the previously selected procedure.
- 9. Coil Cord Port (9, Fig. 2)** – Plug one end of the coil cord (9, Fig. 2) into this port located at the bottom of the handbox and the other end into the HBX port of the computer control panel.
- 10. Coil Cord (10, Fig. 2)** – Plug one end of the coil cord into the HBX port (Fig. 1c) of the computer control panel of the telescope and the other end into the handbox coil cord port.
- 11. Illumination button for the flashlight (11, Fig. 2)** – Turn on the flashlight (12, Fig. 2) in two brightness levels by repeated pressing and then turn it back off again.
- 12. Utility Light (12, Fig. 2)** – Use this built-in red light to illuminate star charts and accessories without disturbing your eye’s adaptation to darkness.
- 13. Port for further developments (11, Fig. 2)** – Never attempt to connect a PC connection cable, not released by the Bresser company, with this interface. This can lead to serious damage of the electronics!

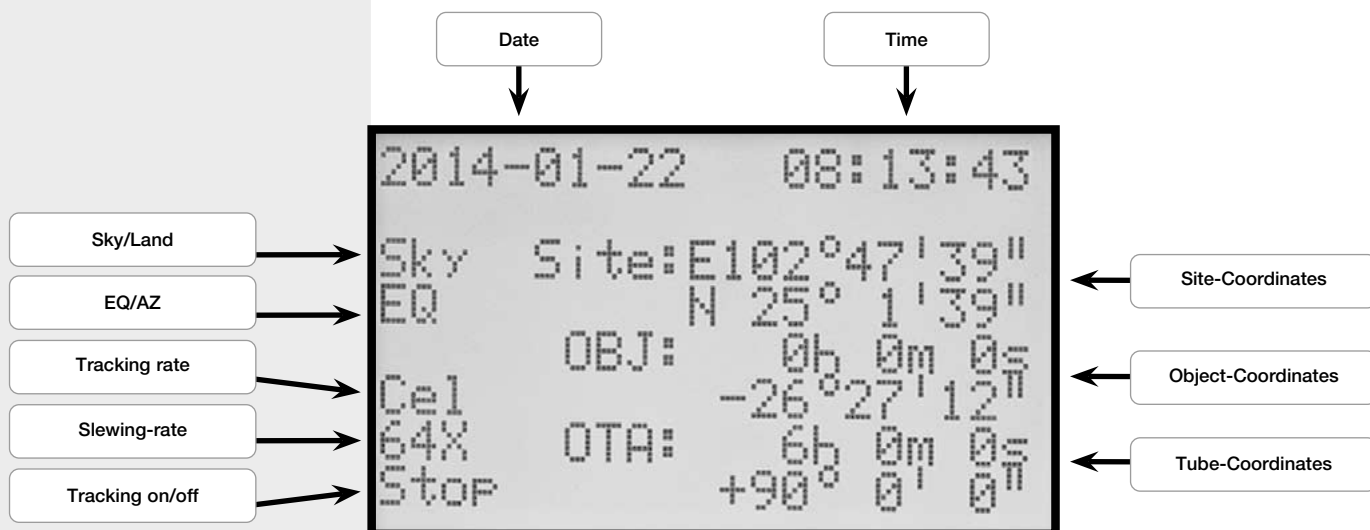

Fig. 2a: Display of the Handbox

Main menu of the Telescope control

Main Menu Overview:

- **Telescope Align**
 - One Star Align Aligns the telescope with a single star
 - Two Star Align Aligns the telescope with two stars
 - Three Star Align Aligns the telescope with three stars
 - Target Sync Further improves the alignment of the telescope
 - RA Bklash Corr. Calibrate RA axis backlash
 - DEC Bklash Corr. Calibrate DEC axis backlash
- **Navigation**
 - Solar System Object catalogue of the solar system
 - Constellation Catalogue with the stellar constellations
 - Famous Star Famous star catalogue
 - Messier Catal. Catalogue with bright deep-sky objects
 - NGC Catalog. Extensive catalogue with broad variety
 - IC Catalogue Catalogue with faint objects
 - Sh2 Catalog. Catalogue with faint objects
 - Bright Star Cat Catalogue with bright stars
 - SAO Star Catal. Extensive star catalogue
 - Customer Objects Allows you to store your own objects
 - Input RA and DEC Insert a custom point in the sky
 - Custom Land Goal Insert a custom land target
- **Utilities**
 - Current Objects Currently visible objects
 - Object Rise/Set Rising and setting time of an object
 - Curr. Lunar Phase The current lunar phase
 - Timer Timer function
 - Alarm Set up an alarm
 - Eyepiece FOV Field of view of the eyepiece
 - Eyepiece Magn. Magnification of the eyepiece
 - Display Illumin. Display brightness
 - Parkposition Slew to park position
- **Setup**
 - Time and Date Enter time and date
 - Daylight Saving Enable/disable daylight saving
 - Site Setting Set the current location
 - Country & City Set the current location according to a city
 - Custom Site Set the current location by using GPS coordinates
 - Sky/Land Switch between sky and land targets
 - Sky Target Setting for sky observation
 - Land Target Setting for land target observation
 - AZ / EQ Switch between Azimuthal and equatorial mounting
 - Alt Telescope Alt./AZ mount type
 - Equ Telescope EQ mount type
 - Telescope Mount Configure telescope mount settings
 - Tracking Rate Set the tracking rate
 - Star Speed
 - Solar Speed
 - Moon Speed
 - Customize Speed
 - Guiding Speed
 - Language Change the language
 - Telescope Model
 - Reset Reset to factory settings

Initializing the handbox

This exercise describes how to initialize the handbox. *Normally, you will enter the Time and Date at the beginning of each observing session, but you will only perform the full Initialization procedure (i.e., entering the Location information and selecting the model number as well as entering the Time and Date) the first time you use the handbox or after performing a Reset.*

1. Make sure that the DEC + RA Lock (1 and 17, Fig. 1a) are tightened according to the manual.
2. Make sure that the control is properly connected to your telescope.
3. Set the power supply switch „ON“. The display field is activated, followed by a copyright message for a short time. Subsequently you will hear a short signal tone. The control now takes a moment to boot up the system.
4. Then you will be prompted to enter the date and time. The date is entered in the „year-month-day / e.g.: 2013-31-12“ format. The time is entered in the „hour-minute-second / e.g.: 20-15-00“ format. Use the arrow buttons for this purpose and confirm your entry with the ENTER button (2 and 5, Fig. 2).
5. You will now be prompted to enter the summertime (Daylight-Saving arrangement). Select the setting „on“, if the telescope is used in the summer time. Select the setting „off“, if the telescope is used outside of the summer time.
6. The next screen queries you about the country and the city of your observing site. You have two different options for entering.
 1. You can select a town in your vicinity, located in the database (select „Country & City“). The countries are listed in alphabetical order in the database. Use the „up and down“ direction buttons to scroll through the countries and cities in the list. When the desired city appears in the display, press the ENTER button.
 2. With manual input (select „Custom Site“), you can set your location information manually. Enter the name („Name“), the longitude („Lon“), the latitude („Lat“) as well as the time zone („Zone“) and confirm your entry with the ENTER button.

Example: Name: Berlin ; Lon: E013° 25` ; Lat: N52° 30` ; Zone: E01

The telescope control now displays this on the main screen and is now ready for alignment in the night sky.

One Star Alignment

After you have completed the initialization, you can align the mounting with the hand box. The fastest and simplest way to use the positioning of the control, is the one-star alignment. The alignment can only take place at night.

1. Bring the telescope in the Polar Home position (Fig. 3b) and close the clamps on both axes.
2. Press 1 x the ENTER button to access the main menu and select the menu item „Alignment“. Then press the ENTER button.
3. Different alignment methods to choose from now appear. Select „One Star“, and then press the Enter button.
4. Now, a choice of alignment stars is displayed. Use the direction buttons „up“ and „down“ to select your desired alignment star and confirm your selection with the ENTER button. The telescope now moves from the starting position, traversing into the vicinity of the selected alignment star.
5. It may happen that the star does not appear in the visual field of the telescope after the positioning. Pick up this star in the visual field with the direction buttons and then centre on it. The alignment star is normally clearly visible and the brightest star in the sky region, which the telescope displays. If you have adjusted the finder scope, it will generally be the brightest star in the visual field of the finder. After the star is centred in the visual field of the eyepiece, press Enter. The successful alignment of the telescope is now confirmed with a acknowledgment tone.

NOTE

As soon as the telescope is aligned once, move it just by using the Goto control or the direction buttons. Do not open the telescopic clamps (1 and 17, Fig. 1a) from this point and also avoid adjusting the base of the telescope manually. Otherwise, the alignment of the telescope could be lost.

NOTE

The hand box calculates the best alignment star based on the location, time and date. The stars can change from night to night and from hour to hour. You, as an observer, need to only centre the stars in the visual field when you are prompted.

NOTE

To further increase the positioning accuracy of the telescope control, adjust the telescope mount using the pole finder scope as precisely as possible to the celestial pole, before alignment occurs. You will find more information as you read the relevant sections.

NOTE

In respect to point 5, always only approach the object in one direction. It is not advisable to take corrective action in the opposite direction, in order to approach the object once again. If necessary, the procedure must be stopped and restarted.

After completion of the “One Star” alignment procedure, the motor drive traverses for the tracking. The telescope is now aligned for an observation night. All objects should retain their position in the eyepiece, even though the earth continues to rotate under the stars.

Two and Three Star Alignment

The implementation is identical, however, repeat steps 4 and 5 twice or three times for more alignment stars.

Synchronisation

With this, the precision of the positioning can be increased. The telescope equilibrates the position of the object with the database after the synchronization. Celestial objects in the surrounding area are then approached more closely.

1. In the “Alignment” main menu, select the “Synchronisation” menu item and press enter.
2. It now displays “Targers Sync. open”. Press ENTER.
3. “Synchronizing” will flash in the display. Press ENTER.
4. Select, in the “Navigation” main menu, e.g. the menu item, “Messier Objects” and select a visible object by pressing the ENTER button.
5. Press the ENTER button again and the telescope approaches the selected object. It could be that you still need to bring Saturn into the centre field of view of the eyepiece with the direction buttons. After this is done, press ENTER.
6. In the “Alignment” main menu, select the “Synchronisation” menu item once again and press Enter.
7. Select “Targers Sync. ensure” (confirm object for synchronisation) and press ENTER. The synchronization is now complete and the position values will be recalculated on the LCD and updated accordingly.

RA + DEC Backlash compensation

For improved accuracy, you can train the gear backlash or “backlash correction of the axis”. This must be done separately for both axes and is not usually necessary. Press the central button (2) to enter the menu and select “Align”. You then select accordingly “RA backlash compensation.” or “DEC backlash compensation.”.

1. Choose the “RA backlash compensation.” menu item and press ENTER.
2. Insert a reticle eyepiece into the eyepiece extension of the telescope.
3. Approach a high-contrast object (e.g. a spire) with the telescope and centre it as accurately as possible in the reticle. Press ENTER.
4. Briefly press the right direction button and wait until a tone sounds.
5. Press and hold the left direction button until such time as the previously set object is situated precisely at the home position on the reticle. Press ENTER.
6. The measured value for the reversal backlash of the RA motor is now displayed in arc seconds.

The “DEC backlash compensation” functions in the same way, except that the “up and down” buttons need to be used here.

Navigation to the Target Objects

NOTE:

Please note that the coordinates of Saturn (and those of the other planets) constantly change in the course of a year. If the selected observation object (e.g. Saturn) is not visible, situated under the horizon, at the set observation time and the location, this is indicated on the LCD with the message „Target under Horizon“. In this case, press 1 x MODE button and select another object from the database.

NOTE:

If the tracking was stopped due to accidental pressing of the MODE button, the tracking can be switched on again by pressing the „STOP“ button twice.

“Go To” Saturn

This exercise shows you how to choose a celestial object, namely Saturn, for observation from the basic data of the hand box.

1. After alignment of the telescope, the main screen appears on the LCD of the hand box. Press ENTER. You are now in the main menu. Select “Navigation” using the direction buttons and press ENTER.
2. You are now in the “Navigation” sub-menu and various selection options of stored observation objects appear that can be approached using the telescope control.
3. Select “Solar System” and press ENTER. “Mercury” appears on the LCD. Scroll in the database, using the “up” and “down” buttons, until “Saturn” appears in the display. Press ENTER. The planet Saturn is then automatically approached by the telescope control. It might be that you still need to bring Saturn precisely into the centre field of view of the eyepiece using the direction buttons.

The control then moves the telescope further automatically. As a result, Saturn (or any other object that you have just selected) is “tracked”, i.e., Saturn is now permanently set in the centre of the eyepiece.

Customer Objects

How you enter the coordinates of an object under the “Customer Object” option of the Navigation menu and approach the object:

1. Make sure that you have initialized the control and aligned the telescope.
2. After aligning the telescope, press the ENTER button to access the main menu.
3. Select the “Navigation” menu option and press ENTER.
4. Select the “Customer Object” menu option. Press ENTER.
5. Select the storage location (F1 - F9) using the direction buttons and press ENTER.
6. You can now enter the object name as well as the object coordinates in the hours / minutes / seconds format for the right ascension axis (Ra) and in the degrees / minutes / seconds format for the declination axis (DEC). Please pay attention to the positive or negative sign of the degree value here. Save your entries with the ENTER button.
7. Press 2 x MODE button so that the main screen is displayed.
8. Press the “F” button (10, Fig. 2) and select the desired storage location. Press the ENTER button. The telescope now approaches the previously stored object coordinates. The object is automatically tracked by the control. It can happen, that the object does not appear in the middle of the visual field of the telescope (eyepiece) after the positioning. Centre the object, in this instance, in the visual field using the direction buttons.

Celestial Coordinates

How you enter the coordinates of an object under the “Input Coordinates” option of the Navigation menu and approach the object:

1. Make sure that you have initialized the control and aligned the telescope.
2. After aligning the telescope, press the ENTER button to access the main menu.
3. Select the “Navigation” menu option and press ENTER.

4. Select the "Input Coordinates" menu option. Press ENTER.
5. You can now enter the object name as well as the object coordinates in the hours / minutes / seconds format for the right ascension axis (Ra) and in the degrees / minutes / seconds format for the declination axis (DEC). Please pay attention to the positive or negative sign of the degree value here. Save your entries with the ENTER button.
6. Press ENTER. The telescope now approaches the previously stored object coordinates. The object is automatically tracked by the control. It can happen, that the object does not appear in the middle of the visual field of the telescope (eyepiece) after the positioning. Centre the object, in this instance, in the visual field using the direction buttons.

Terrestrial Objects

This function is not yet available in the software version 2.2!

Utility Menu

Here you will learn further details about the additional functions of the telescope control.

Current Objects

The planets, visible at your location in real-time, can be displayed here with the actual calculated rise and setting times as well as the time of culmination (its highest position in the south = best visibility).

Note: Please note that the telescope control has been previously initialized successfully.

Rise and Setting Time

If you would like to know of the calculated rise and setting times as well as the time of culmination (its highest position in the south = best visibility) of a desired object, visible at your location, you can calculate this using this menu item. You will return to the main menu upon pressing of the MODE button.

Note: Please note that the telescope control has been previously initialized successfully.

Lunar Phase

Here, the Moon phases of the currently selected month are displayed graphically. The numbers refer, in this case, to the graphics belonging to the day. Using the arrow buttons, you can change the year and month. Thereby the phases of the moon are calculated once again instantly and displayed. You will return to the main menu upon pressing of the MODE button

Note: Please note that the telescope control has been previously initialized successfully.

Timer

The timer function can be set so that a signal tone will sound according to a set time reference. This can, e.g., be useful for making sure exposure times for astrophotography are respected to the second. To do this, enter the desired time in seconds and press ENTER, as soon as the timer is to be started. You will return to the main menu upon pressing of the MODE button.

Alarm

The alarm function can be set so that a signal tone will sound according to a set time reference. This can, e.g., be useful for making sure you do not miss celestial events planning. To do this, enter the desired time in the 24 hour format and press ENTER, as soon as the alarm is to be activated. You will return to the main menu upon pressing of the MODE button. If you want to deactivate the alarm prematurely, select the "Alarm" menu item again and confirm "Close Alarm?" with ENTER.

NOTE

Please note that the telescope control has been previously initialized successfully.

Eyepiece Field of View

The eyepiece FOV (Field of view) function can calculate the field of view of a particular eyepiece. After you enter the focal length of the telescope used (MF), the focal length of the eyepiece (SF) and the apparent visual field of the eyepiece (E-FOV), press ENTER. The size of the field of view in degrees is then displayed on the bottom line of the LCD.

Eyepiece Magnification

The eyepiece magnification function can calculate the magnification of a certain eyepiece. After you enter the focal length of the telescope used (MF), and the focal length of the eyepiece (SF), press ENTER. The calculated magnification is then displayed on the bottom line of the LCD. You will return to the main menu upon pressing of the MODE button.

LCD Illumination

Select this function to adjust the illumination of the screen. Use the “up and down” buttons to select a suitable level of illumination in this case. You will return to the main menu upon pressing of the MODE button.

Park Scope

Select this function to allow the telescope to traverse to the park position (starting position). Switch off the telescope control after reaching the parking position.

Settings

Here you can read more details on the setting possibilities of this telescope control.

Date and Time

The date is entered in the „year-month-day / e.g.: 2013-31-12“ format. The time is entered in the „hour-minute-second / e.g.: 20-15-00“ format. Use the arrow buttons for this purpose and confirm your entry with the ENTER button.

Daylight Saving

Select the setting (Daylight-saving) „on“ , when the telescope is used in the summer time. Select the setting „off“, if the telescope is used outside of the summer time.

Note:

Pay attention to the correctness of such data, because otherwise there will be deviations during the calculations and the objects, where applicable, will not be approached precisely.

Observing Site

Here you can set your observation location. You have two different options for entering:

1. You can select a town in your vicinity, located in the database (select „Country & City“). The countries are listed in alphabetical order in the database. Use the „up and down“ direction buttons to scroll through the countries and cities in the list. When the desired city appears in the display, press the **ENTER** button.
2. With manual input (select „Custom Site“), you can set your location information manually. Enter the name („Name“), the longitude („Lon“), the latitude („Lat“) as well as the time zone („Zone“) and confirm your entry with the **ENTER** button.

Example:

Name:

Berlin ; Lon: E013° 25` ;

Lat: N52° 30` ; Zone: E01

Time zone east of Greenwich:

E01-E12

Time zone west of Greenwich:

W01-W12

Time zone: Greenwich (GMT):

E00 oder W00

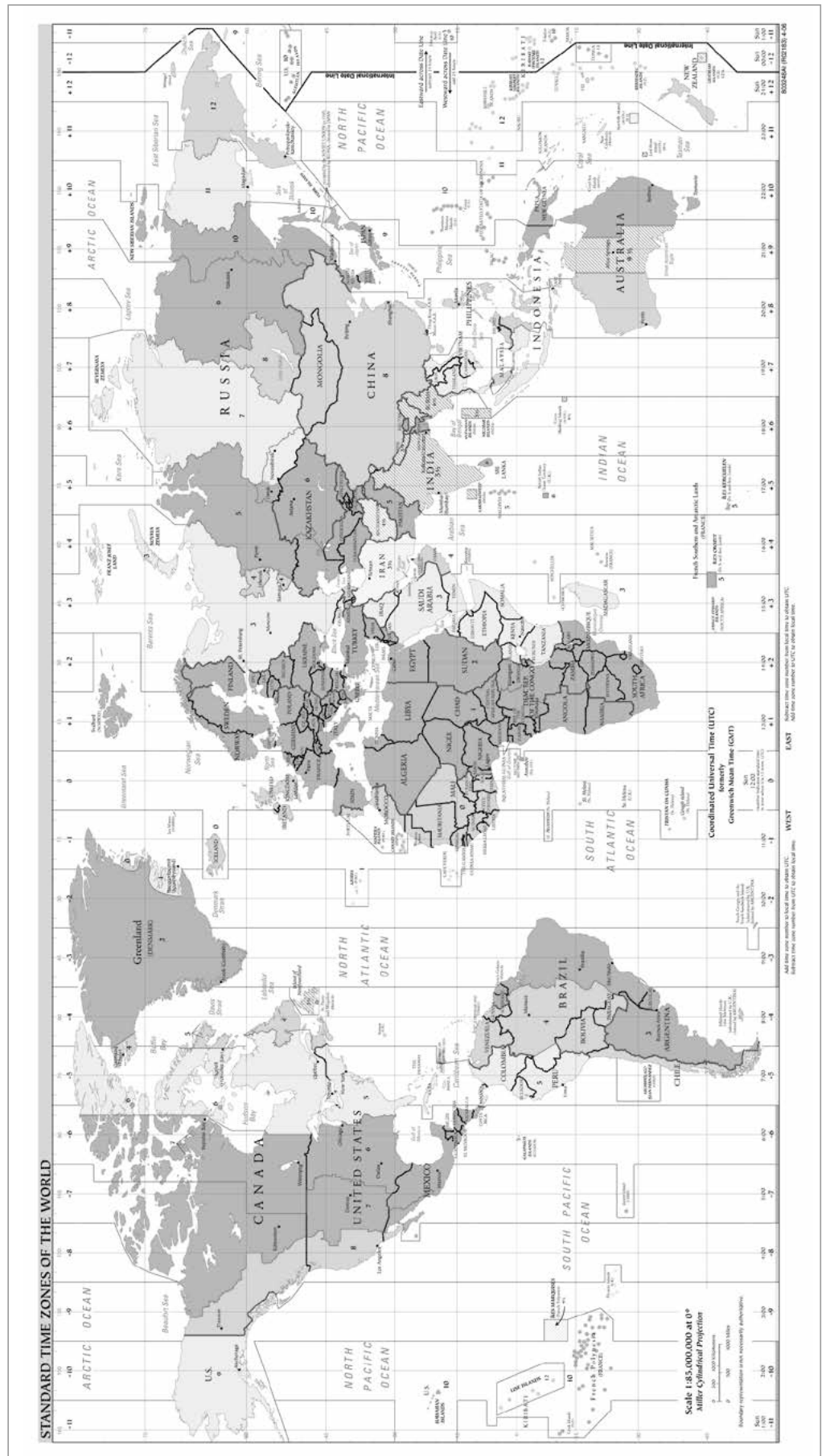

Astronomical / Terrestrial

This function is not yet available in the software version 2.2!

Tracking Mode

This function is not yet available in the software version 2.2!

Telescope Mount

This function is not yet available in the software version 2.2!

Tracking Rate

Here, you are able to adjust the speed of the automatic tracking. Select the desired option and press ENTER. The following options can be set:

Star Speed:	Sidereal speed / star speed (standard factory setting)
Solar Speed:	Sun speed
Moon Speed:	Moon speed
Customize Speed:	This function is not yet available in the software version 2.2!
Guiding Speed:	Adjustment of the reaction speed with Auto-Guiding via ST-4 interface (astrophotography). The setting of 1000 results in an aggressive reaction of the drive motors. Settings with lower values result in a sluggish response. This setting should be individually adjusted with each telescope mounting to obtain the most uniform possible or precise tracking. For this purpose, essential accessories, e.g. ST-4 compatible Guiding cameras are available from accessory suppliers.

Language

Select your preferred language. The following options are available: English, German, French, Italian , Spanish

Telescope Model

This function is not yet available in the software version 2.2!

Reset

This allows you reset the telescope control to the factory settings. This is necessary when, for example, all your settings should be undone or where a system error occurs. You must then initialize the telescope control again as well as enter all customer data once more.

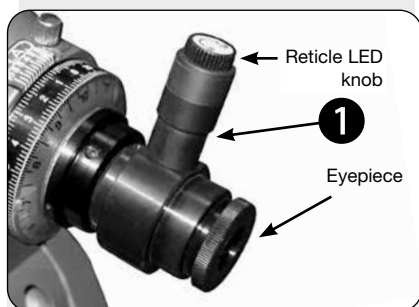

Fig. 4: The polar alignment viewfinder

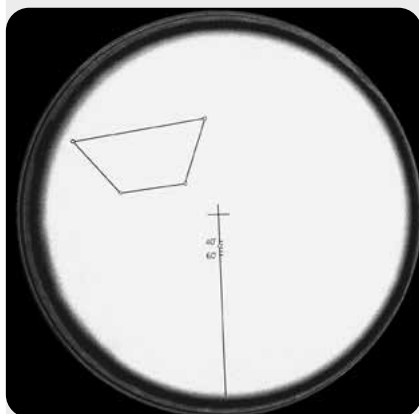

Fig. 5: The view inside the polar alignment viewfinder reticle (the four stars show an association near the southern celestial pole)

Polar Alignment

The Polar Alignment Viewfinder

Normally, a rough alignment with the celestial pole is sufficient for visual purposes. However, for those observers who need to meet the more demanding requirements of astrophotography, the polar alignment viewfinder allows the telescope mount to be more precisely aligned with true North. The Exos2 Mount can be equipped with a red LED illumination for the finder scope (available separately).

Adjusting the polar viewfinder (EXOS 2 only)

A. Calibrating the month circle at the polar viewfinder scope (best done while daytime)

1. Point the viewfinder against a bright surface (not in any case at the sun!) and see the scaled line with the center cross (Fig. 5). Turn the viewfinder's eyepiece until the scales are focussed.
2. Now turn the month circle against the viewfinder until the 1st of May hits the vertical line. The month circle is secured by a counterring; it should be able to be turned but it should not come loose. Now you can put the viewfinder back into the RA axis
3. On the month circle, there's a second scale, marked "E 20 10 0 10 20 W". Take a white pencil and mark the point on the viewfinder that is right above the "0". This can be also done by using a small piece of colored tape.

B. Aligning the viewfinder's optical axis to the RA axis (EXOS 2 only)

1. Starting at the polar home position, loosen the Dec lock, turn the Dec axis by 90° and re-engage the Dec lock again. In this position, the optical axis of the viewfinder is free.
2. Point the viewfinder at a terrestrial objekt like a phone pole, the tip of a church tower or equiv. so that it lines up with the center cross of the reticle.
3. Ascertain whether the object moves out of the center cross when the mount is rotated around its Dec axis.
4. If this is the case, correct 50% of the error by adjusting the hex screw of the viewfinder holder. Now correct the remaining error by repositioning the mount. Turn the RA axis by 90 / 180° and repeat this process until the center cross stays on the desired object.

Polar alignment by using the polar viewfinder (EXOS 2 only)

1. Set the polar home position (see p. 8). Loosen the Dec lock, turn the Dec axis by 90° and re-engage the lock.
2. Loosen the RA lock
3. Remove the dust caps
4. If not done yet, remove the isolaton pad from the viewfinder's illumination.
5. Turn the illuminator switch clockwise to a comfortable brightness and look through the viewfinder. If necessary, focus the viewfinder until reticle and stars appear sharp.
6. In the following step 7, use the latitude adjustment screws and the azimuth adjustment screws to do the necessary fine adjustments



Fig. 6: Detail: Polar viewfinder.

Polar finder scope illumination (1) available separately.

Observers on the northern hemisphere:

N-7 a) Determine the rough longitude of your observing site (example: Munich is 12° E). Now determine the longitude of the time meridian according to your local time. For the central european time, this is 15° E (do not use daylight savings). Calculate the difference between both longitudes; in our example with Munich, it is 3°

N-7 b) Now set the secondary scale at your month ring (E 20 10...) to this difference. If your observing site is east of the time meridian, turn to "E", if it is west of the meridian, turn to "W". This setting has only to be changed when the observing site changes by more than 2-3°.

N-7 c) Loosen the RA setting circle locking screw, turn the setting circle to "0" and tighten the screw again. In normal operation, this screw should be loose!

N-7 d) Now loosen the RA lock and turn the RA axis until the actual date at the month match with the local time. In the picture shown, this would e.g. be November 24th, 22:00 CET.

N-7 e) Now adjust the mount using the azimuth and latitude knobs until Polaris fits into the small circle between 40' and 60'.

Observers on the southern hemisphere:

S-7 a) Look at the trapezoid association in the polar viewfinder's reticle. They build the stars Sigma, Tau, Chi and Ypsilon Octantis. Turn the RA axis until the "real" stars roughly cover the edge points in the trapezoid figure.

S-7 b) Probably both trapezoids may still be parallel shifted. Adjust this offset by using the latitude and azimuth fine controls. Maybe an additional RA correction is necessary.

NOTE:

Not all settings within the month/hour scale are possible because a german equatorial mount is limited within its movements.

8. Tighten the RA wedging again and set the telescope to its polar home position.

NOTE:

Don't forget to switch off the reticle illuminatin after use.



Abb. 7: The Andromeda Galaxy (M31), the biggest one in our local group.

How to find the polar star

Based on both „pointer stars“ - the two rear stars of the bowl of the Big Dipper - draw a line, between these two stars and extend it out about 5 times till you reach the polar star. Extend this line further, well above the polar star, then you will reach the great star quadrant, which Pegasus and Andromeda share with one another.

The Summer Triangle illustrates a striking celestial region to the left of the handle of the Big Dipper. This triangle consists of three very bright stars: Vega, Deneb and Atair.

If you draw an imaginary straight line in the direction of the Dipper arc, you will arrive at the summer constellation Scorpius. The scorpion curves in the sky like a scorpion's tail to the left, it looks a bit like the letter „J“.

The American amateurs have coined the saying „Arc to Arcturus and spike to Spica“. They therefore refer to a celestial region, which is situated in the immediate extension of the arc, which is described by the arc of the Big Dipper. Follow the arc to Arcturus, the brightest star in the northern hemisphere, and then „point“ down to Spica, the 16th-brightest star in the sky.

Hint:

Star Charts

Star charts and planisphere are very useful tools and are great aids in planning a night of celestial viewing.

A wide variety of star charts are available in books, in magazines, on the internet and on CD Roms.

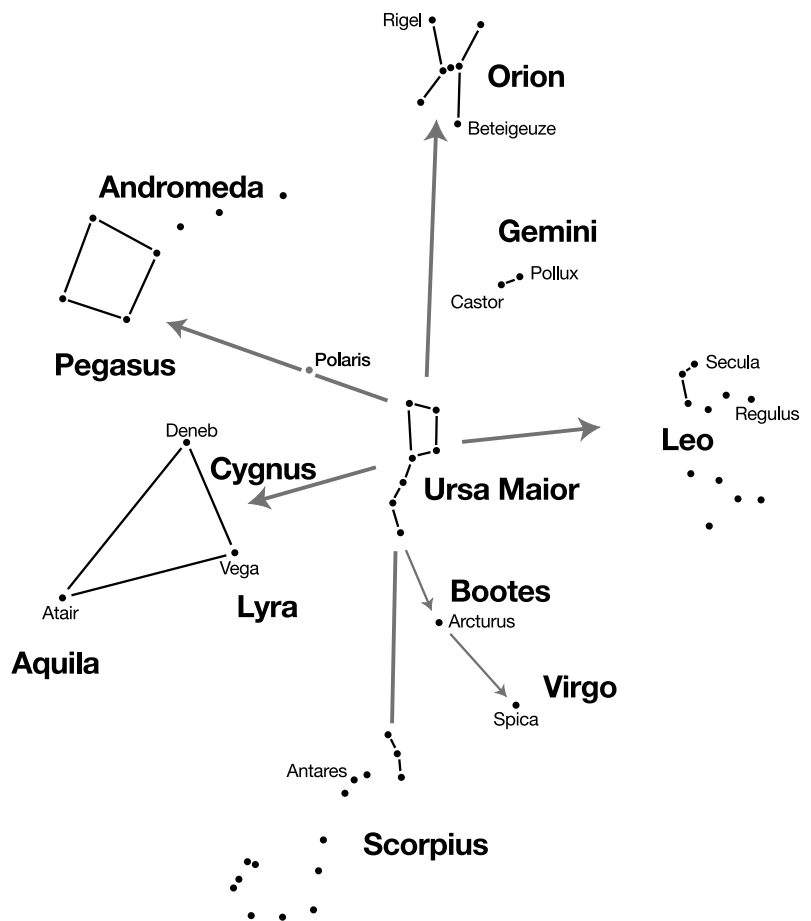

Distances in space

Distance between Earth and Moon

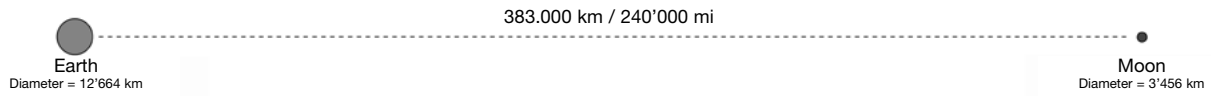

Distance between Planets

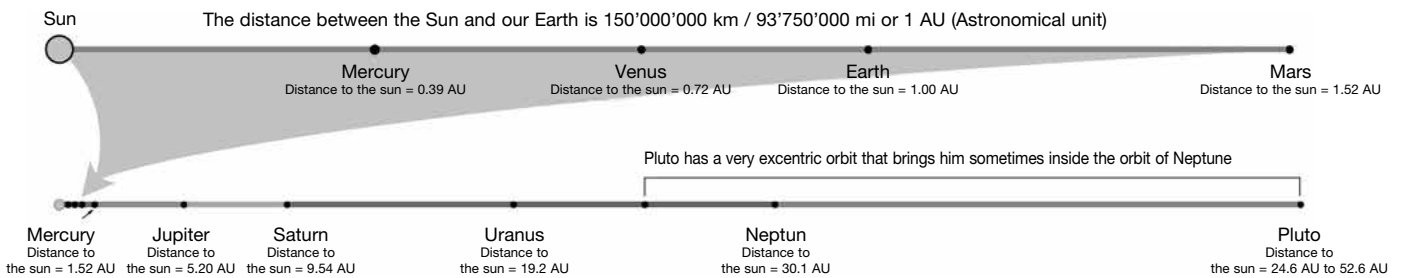

Distance between Stars

The distance between our Sun and the nearest star is about 4,3 light years or etwa 40 Billion km. This distance is so enormous, that in a model where our Earth is 25 mm (1 inch) distant from the sun, the distance to the next star would be 6.5 km/4 mi!

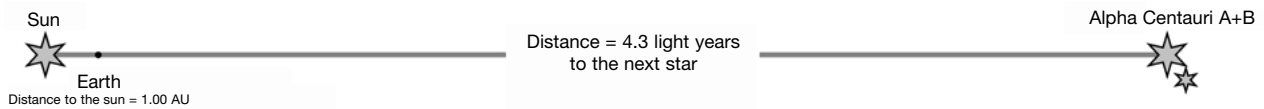

Our home galaxy, the Milky Way, inhabits round about 100'000'000'000 stars. With its spiral arms, it has a diameter of about 100'000 light years.

Distances between galaxies

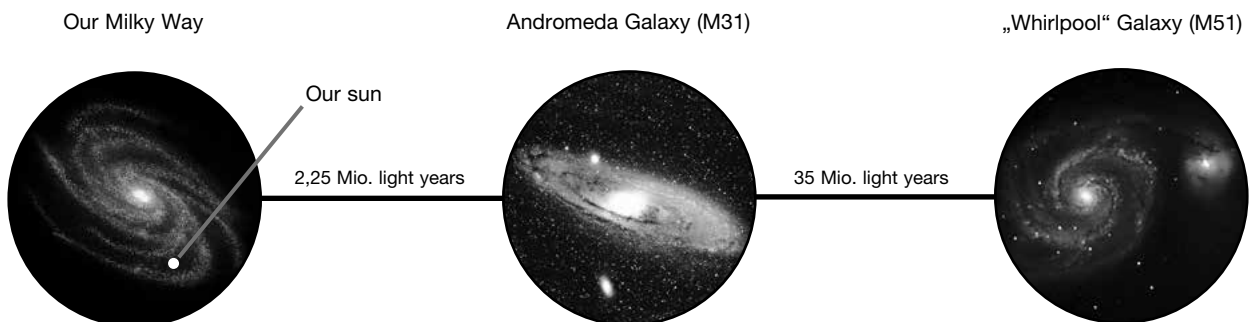

Possible observation targets

The following section details several interesting and easy-to-find celestial objects you may want to observe through your telescope.

The moon

The moon is Earth's only natural satellite.

Diameter: 3,476 km

Distance: 384,400 km from Earth (average)



The moon has been known to humans since prehistoric times. It is the second brightest object in the sky, after the sun. Because the moon circles the Earth once per month, the angle between the Earth, the moon and the sun is constantly changing; one sees this change in the phases of the moon. The time between two consecutive new moon phases is about 29.5 days (709 hours).

Constellation Orion: The Orion Nebula (M 42)

Right Ascension: 05^h 35^m (hours : minutes)

Declination: -05° 22' (Degrees : minutes)

Distance: 1,344 light years from Earth



Though it is more than 1,344 light years from Earth, the Orion Nebula (M 42) is the brightest diffuse nebula in the sky. It is visible even with the naked eye and a worthwhile object for telescopes of all types and sizes. The nebula consists of a gigantic cloud of hydrogen gas with a diameter of hundreds of light years.

Constellation Lyra: The Ring Nebula (M 57)

Right Ascension: 18^h 53^m (hours : minutes)

Declination: +33° 02' (Degrees : minutes)

Distance: 2,412 light years from Earth

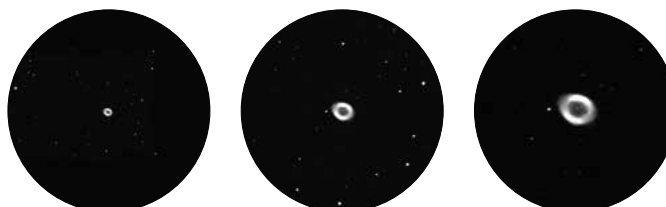

The famous Ring Nebula (M57) in the Lyra constellation is often viewed as the prototype of a planetary nebula. It is one of the magnificent features of the Northern Hemisphere's summer sky. Recent studies have shown that it is probably comprised of a ring (torus) of brightly shining material that surrounds the central star (only visible with larger telescopes), and not a gas structure in the form of a sphere or an ellipse. If you were to look at the Ring Nebula from the side, it would look like the Dumbbell Nebula (M 27). When viewed from Earth, we are looking directly at the pole of the nebula.

Constellation Vulpecula (Little Fox):

The Dumbbell Nebula (M 27)

Right Ascension: 19^h 59^m (hours : minutes)

Declination: +22° 43' (Degrees : minutes)

Distance: 1,360 light years from Earth



The Dumbbell Nebula (M 27) was the first planetary nebula ever discovered. On 12 July 1764, Charles Messier discovered this new and fascinating class of objects. We see this object almost directly from its equatorial plane. If we could see the Dumbbell Nebula from one of its poles, we would probably see the shape of a ring, something very similar to what we know as the Ring Nebula (M 57). In reasonably good weather, we can see this object well, even with low magnification.

Technical Data

Article Description: Bresser Goto Set

Article Number: 49-51750

Suitable mountings: Bresser EXOS II and EQ-5 compatible model series

Required ratio of the worm gear 144:1

Number of stored objects: < 100.000

Max. speed of the drive: 2° / second

Auto-Guider Port: Yes / ST-4 compatible

LCD Display: 36 x 63mm ; 8 lines with 21 characters each

Drives: DC servo motors with rotary encoders

Operating voltage: 12V DC

Connection power supply: DC- plug 5.5/2.5mm

Polarity of the 12V connection socket: pin inside + / plug shaft unit -

Battery Compartment: Yes / 8 x D-cell / LR20 (batteries not included)



Bresser GmbH
Gutenbergstr. 2
DE-46414 Rhede
Germany

www.bresser.de
service@bresser.de